



FANATEC®

PODIUM

RACING WHEEL F1®



Manual

EN



“PS”, PlayStation, “PS4” and “△○×□” are registered trademarks of Sony Interactive Entertainment Inc. All rights reserved.
All other trademarks are the property of their respective owners.

Thank you for choosing
FANATEC[®]

To get the most out of your Podium Racing Wheel F1[®], please read this manual before use. It contains important health and safety information and should be retained for future reference.

INDEX

1. General	5-6
2. Introduction	7
3. Compatibility	7
4. Plug & Play	8-10
5. Preparation	11-12
5.1 Package contents	11-12
6. Assembly	13-22
6.1 Plan your configuration	13
6.2 Mounting the Podium Racing Wheel F1® using the ClubSport Table Clamp V2	13
6.3 Hard-mounting the Podium Wheel Base DD1 PS4™	13-14
6.4 Attaching a Steering Wheel	15-17
6.5 Changing the Quick Release	18-19
6.6 Connections	20-21
6.7 Drilling Template	22
7. Functions & Features	23-38
7.1 Firmware and driver update	23-32
7.2 Start-Up procedure	32-33
7.3 Tuning Menu	33-36
7.4 OLED Display	37
7.5 Cooling system	38
8. Electronic operation	39-42
8.1 Hotkeys	39-42
9. Cleaning	43
10. Troubleshooting	43-44
11. Serial number	45
12. Trademarks	45
13. End of Life Product Recycling	46-49
14. FCC Compliance	50
15. Warranty	51-52

 **WARNING!** Musculoskeletal disorders

Use of game controllers, keyboards, mice, or other electronic input devices may be linked to serious injuries or disorders. When playing video games, as with many activities, you may experience occasional discomfort in your hands, arms, shoulders, neck, or other parts of your body. However, if you experience symptoms such as persistent or recurring discomfort, pain, throbbing, aching, tingling, numbness, burning sensation, or stiffness, **DO NOT IGNORE THESE WARNING SIGNS. PROMPTLY SEE A QUALIFIED HEALTH PROFESSIONAL**, even if symptoms occur when you are not playing a video game. Symptoms such as these can be associated with painful and sometimes permanently disabling injuries or disorders of the nerves, muscles, tendons, blood vessels, and other parts of the body. These musculoskeletal disorders (MSDs) include carpal tunnel syndrome, tendonitis, tenosynovitis, vibration syndromes, and other conditions.

While researchers are not yet able to answer many questions about MSDs, there is general agreement that many factors may be linked to their occurrence, including medical and physical conditions, stress and how one copes with it, overall health, and how a person positions and uses their body during work and other activities (including playing a video game). Some studies suggest that the amount of time a person performs an activity may also be a factor. If you have questions about how your own lifestyle, activities, or medical or physical condition may be related to MSDs, see a qualified health professional.

1

GENERAL

 **ATTENTION**

- The device must not be exposed to rain or humidity in order to avoid risk of fire and/or electric shock.
- Operating room temperature: 15°C-35°C
- The recommended operation time of the wheel with continuous force feedback activity is 1 hour.
- Excessive use may cause health risks. We recommend to take a break of 5 minutes every 20 minutes, and do not drive for more than 2 hours per day.
- Not intended for children under the age of 13 years old. Contains small pieces which pose a choking hazard!
- Do not open the casing of the device.
- This device contains components that cannot be repaired by the user, opening will void the warranty.

 **WARNING!** Electrical Safety

- The Podium Racing Wheel F1® must be connected to an appropriate power source:
 - Always connect the DC side of the power supply to the wheel base before connecting the AC side of the power supply to your wall socket.
 - Use only the power supply and power cord that came with your Podium Racing Wheel F1®. Replacements may only be issued from an authorised repair centre.
 - Do not use non-standard power sources, such as generators or inverters, even if the voltage and frequency appear acceptable. Only use AC power provided by a standard wall outlet.
- To avoid damage, do not expose your Podium Racing Wheel F1® to sources of heat.
- When connecting and / or disconnecting any steering wheel to / from Podium Racing Wheel F1® take care of the pins inside the Quick Release.
- Only use Fanatec® steering wheels with the Podium Racing Wheel F1® base.
- Unplug the power cord of your Podium Racing Wheel F1® during storms or when unused for long periods of time.
- If the Podium Racing Wheel F1® becomes damaged in any way, stop using it immediately and contact Fanatec® Customer Support <http://www.fanatec.com/support>.



GENERAL NOTES

- Podium Racing Wheel F1® is fully usable out-of-box. We always recommend updating to the latest firmware. See chapter 'Firmware and driver update' for more details. A PC is required to update your firmware.
- All specifications in this document are subject to change. The Podium Racing Wheel F1® firmware and/or PC driver may be updated to implement new features or general improvements.
- This product contains the ClubSport Steering Wheel F1® PS4™, all other Fanatec® steering wheels which might be mentioned in this manual are not included within the Podium Racing Wheel F1® package and sold separately. You can obtain them from the Fanatec webshop: www.fanatec.com
- Additional peripheral devices like shifters, pedals, LED displays and others which might be mentioned in this manual are not included within the Podium Racing Wheel F1® package and are sold separately. You can obtain them from the Fanatec Webshop: www.fanatec.com
- This manual discusses assembly, connections, and functions related to Fanatec® steering wheels and other additional devices (e.g. PlayStation®4 and PCs.) This is not a replacement manual for the other corresponding products! Read the quick guides or user manuals for the other products as well!
- The warranty does not include defects that are due to commercial use of the product. See chapter "Warranty" at the end of this user manual as well as the Terms & Conditions at www.fanatec.com for more details.
- Manufactured & distributed under license from Sony Interactive Entertainment Europe.
- "PlayStation" and the "PS" Family logo are registered trademarks of Sony Interactive Entertainment Inc.

2

INTRODUCTION

Thank you for purchasing the Podium Racing Wheel F1®, officially licensed by Formula 1™ and for PlayStation®4. At its core is the Podium Wheel Base DD1 PS4™, which contains many advanced technologies, including a custom outrunner servo motor, integrated electronics, and wireless Quick Release system. Built from the ground up for sim racing, the motor delivers 20Nm peak torque, with outstanding wheel speed and acceleration. This is the most realistic force feedback system ever created for PlayStation®4. Welcome to the Direct Drive Revolution.

The product also includes the ClubSport Steering Wheel F1® PS4™, fitted with the Podium Advanced Paddle Module. This steering wheel is packed with functionality, including 12-way multi-position switches, thumb encoders, and toggle switches. The paddle module features F1®-style dual clutch paddles and dual magnetic shifters, plus two additional magnetic paddles.

3

COMPATIBILITY

The Podium Racing Wheel F1® (P RW F1) can be used with a wide range of CSL and ClubSport series steering wheels. Using different wheels helps to create a more realistic feeling based on the type of vehicle being simulated, and your driving style. It's up to you! Additional peripheral devices from Fanatec® such as pedals, shifters and handbrake are fully compatible with the Podium Racing Wheel F1®. You can obtain them from the Fanatec webshop: www.fanatec.com

The Podium Racing Wheel F1® can be used on PlayStation®4 and PC*.

Other platforms: Compatibilities to other platforms depend on the used steering wheel. For more information, please check the product page of the steering wheel you plan to use.

 **IMPORTANT:** Podium Racing Wheel F1® is fully usable out-of-box. We always recommend updating to the latest firmware. See chapter 'Firmware and driver update' for more details. A PC is required to update your firmware.

*PC compatibility not tested nor endorsed by Sony Interactive Entertainment Europe

4

PLUG & PLAY

This chapter provides a quick summary for setup, and is not a replacement for the chapters that follow; we strongly recommend reading the later chapters to gain a full understanding of the product's many features, and to achieve the best user experience. Especially refer to chapter 10 'Troubleshooting' to get quick help if needed.

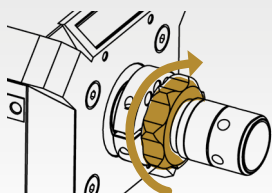

Position the locking ring until it touches the rubber gasket, but do not tighten. This keeps the rubber gasket in place during wheel rim attachment.

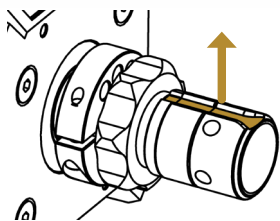

Centre the Quick Release shaft so the slot is at the top.

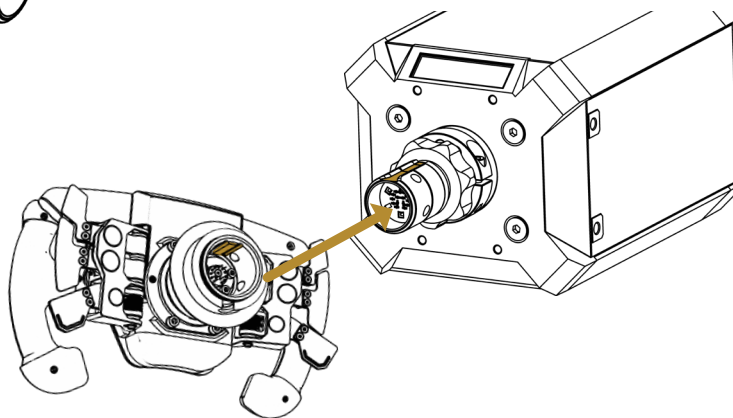

Pull and hold the Quick Release sleeve and carefully push the steering wheel onto the shaft. Release the sleeve.

When using the Fanatec ClubSport Quick Release on a Podium Wheel Base, no bolt is required.

Turn the locking ring counter clockwise for a tight fit.

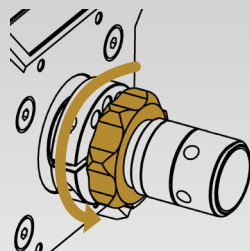

Side mounting:

On both sides of the wheel base are two M8-threaded holes which are 20mm deep:

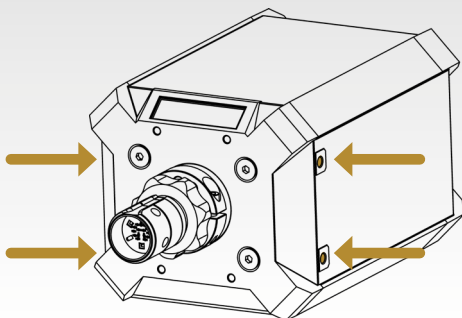

Bottom mounting:

On the underside of the wheel base are five M6-threaded hole patterns which are 12mm deep for Fanatec triangular mounting and square mounting (78,4mm x 66mm):

Using the front centre hole with the two rear holes (Fanatec Triangular mounting - marked with gold arrows) is sufficient for use.

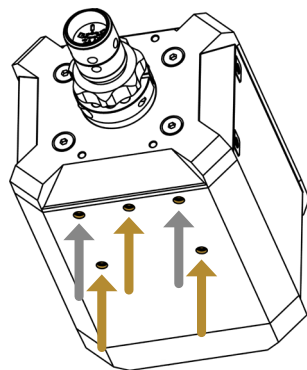

Fanatec offers optional Podium Mounting Brackets for side mounting, and the ClubSport Table Clamp V2 can also be used. Fanatec pedals are required for operation on PS4™. You can obtain these add-on products from the Fanatec webshop: www.fanatec.com

Connect your peripheral devices to the corresponding port at the back of the Podium Racing Wheel F1®.

Also connect the PS4™ system or your PC** to the USB port and plug in the power supply.

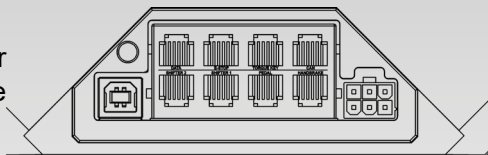

Power on the Podium Racing Wheel F1® and wait until calibration run is completed.

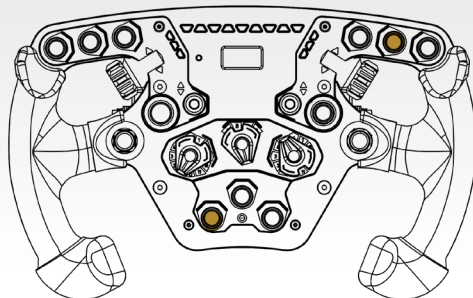

The current active operation mode is indicated on the upper left corner of the wheel base's OLED display:

- PS4™: To operate with PlayStation®4 and any Fanatec steering wheel*
- PC**: To operate with Windows PCs** and any Fanatec steering wheel*
- Comp V2.5: To operate with older games on Windows PCs use this mode to emulate a ClubSport Wheel Base V2.5 with any Fanatec steering wheel*. There is no performance penalty when using this mode.
- Comp PS4™: Some older games on Playstation®4 may require the use of this mode, which emulates a CSL Elite Wheel Base + with any Fanatec steering wheel*

Your setup is ready to use now. If you have difficulties please check the following chapters of this user manual, there are much more detailed descriptions for each of the above steps.

* optional and not included in this product package

**PC compatibility not tested nor endorsed by Sony Interactive Entertainment Europe

5

PREPARATION

5.1 Package contents

Podium Wheel Base DD1 PS4™

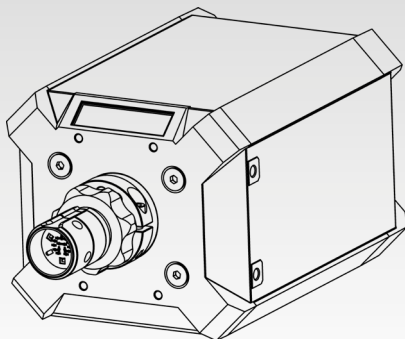

Power supply unit

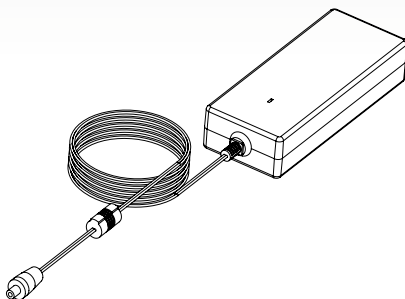

Power supply cable

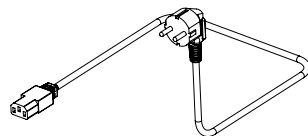

USB connection cable with straight plug

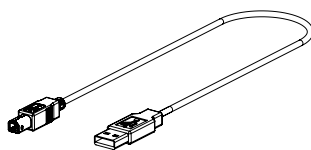

Torque Key

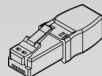

RJ12 connection cable for Pedals

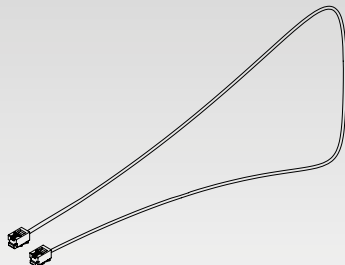

ClubSport Steering Wheel F1® PS4™

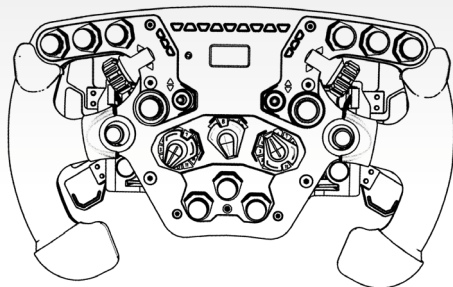

Cylinder head bolt ISO 4762 M6x20
(only for Simplified Quick Release)



Cylinder head bolt ISO 4762 M6x20
(only for ClubSport Quick Release)



Racing style button caps for
ClubSport Steering Wheel F1® PS4™



PS4™ button caps for (already installed on
the steering wheel)
ClubSport steering wheels



Quick Guide

6

ASSEMBLY

6.1 Plan your configuration

To operate the Podium Racing Wheel F1® plug your steering wheel onto the Quick Release of the Podium Wheel Base DD1 PS4™ and get started. Connect the Podium Racing Wheel F1® to your PlayStation®4 system or PC* by using the USB cable.

Please check the 'Connections' chapter to see which kind of peripheral devices must be connected to which socket on the Podium Racing Wheel F1®. All devices have to be connected to the Podium Racing Wheel F1® before powering ON to allow proper detection and operation.

6.2 Mounting the Podium Racing Wheel F1® using the ClubSport Table Clamp V2

While it is recommended to hard-mount the Podium Racing Wheel F1® to a dedicated cockpit, it is possible to use on a strong flat surface using the Fanatec ClubSport Table Clamp V2. Just bolt the Podium Racing Wheel F1® to the Table Clamp with four bolts on the underside of the base.

- You need to take apart the angled plate by loosening the Allen bolt to remove the rod.
- Then you can bolt the plate on the Podium Racing Wheel Base but be careful! **Pay attention to the length regulation on page 14!**
- Now insert the rod and tighten it with the Allen bolts.
- Open the two metal bolts as much as you need to place on the table.
- Tighten the two metal table clamp bolts. Ensure that the table clamp's feet remain well aligned with the bottom of the table plate.

*PC compatibility not tested nor endorsed by Sony Interactive Entertainment Europe

6.3 Hard-mounting the Podium Wheel Base DD1 PS4™

ATTENTION: Not for hard-mounting!
Only for peripheral mounting such as static shifter paddles or a dash display.

Thread length of holes: 7 mm
Required bolts: M6

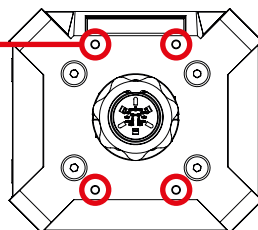

The Podium Wheel Base DD1 PS4™ offers several mounting options (shown below).

Side mounting:

On both sides of the wheel base are two M8-threaded holes which are 20mm deep. There you can mount the Podium Mounting Brackets (not included):

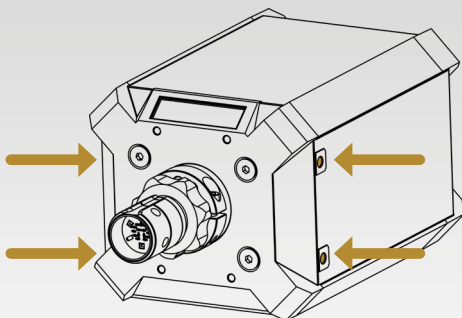

⚠ IMPORTANT: Use only good quality M8 bolts. Choose the bolt length so that the thread does not reach more than 20 mm into the wheel base. Always use all four hard-mount points, this allows a proper and stable installation and avoids damage!

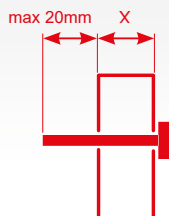

Bottom mounting:

On the underside of the wheel base are five M6-threaded hole patterns which are 12mm deep for Fanatec triangular mounting and square mounting (78,4mm x 66mm):

Using the front centre hole with the two rear holes (Fanatec Triangular mounting - marked with gold arrows) is sufficient for use.

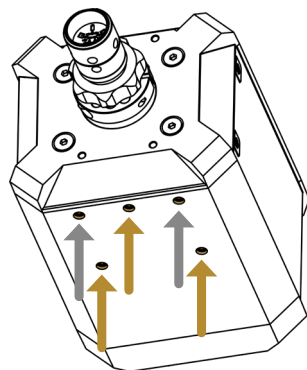

⚠ IMPORTANT: Use only good quality M6 bolts. Choose the bolt length so that the thread does not reach more than 12 mm into the wheel base. Always use all three hard-mount points, this allows a proper and stable installation and avoids damage!



To hard-mount the Podium Wheel Base DD1 PS4™ to a table or rig by bolts please find the printable drilling template in the download area of our website www.fanatec.com.

6.4 Attaching a Steering Wheel

6.4.1 Attaching Fanatec Steering Wheels with Simplified Quick Release

Use the clamp ring bolt included with the Podium Racing Wheel F1® package and use the Allen key included with your steering wheel package.

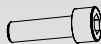

It is recommended to turn the wheel base off before attaching a steering wheel with Simplified Quick Release. Centre the Quick Release shaft so the slot is at the top.

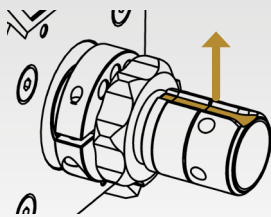

Note: When a Fanatec steering wheel with Simplified Quick Release is used on a Podium Wheel Base, the torque will automatically reduce to the level of the ClubSport Wheel Base V2.5.

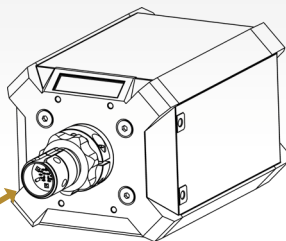

Slide any Fanatec Steering Wheel with Simplified Quick Release onto wheel base shaft.

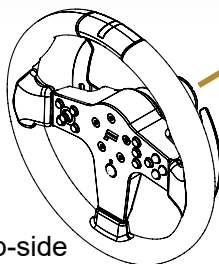

Turn the Simplified Quick Release top-side down to see the bottom of the clamp ring to follow next step below.

Note: While doing this, make sure there is no force feed back effect active. It would be best to turn the wheel base off.

Push the Fanatec Steering Wheel until the bolt hole aligns with the hole on the wheel base shaft.

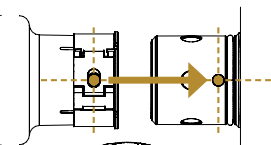

Tighten bolt to fix clamp ring mechanism, use only the Allen key provided with the Fanatec Steering Wheel.

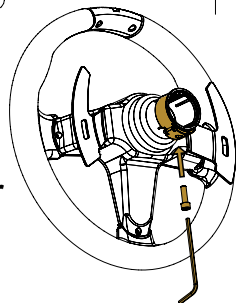

! IMPORTANT: Tighten only by using the short lever of Allen key!

6.4.2 Attaching the ClubSport Steering Wheel F1® PS4™

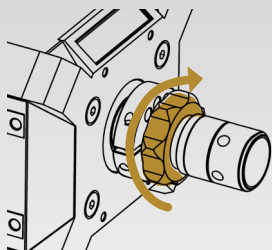

Position the locking ring until it touches the rubber gasket, but do not tighten. This keeps the rubber gasket in place during wheel rim attachment.

⚠ IMPORTANT: Do not over-loosen the locking ring to the end of the steering axle before attaching a steering wheel! The rubber ring will not sit in position to hold the Steering Wheel properly.

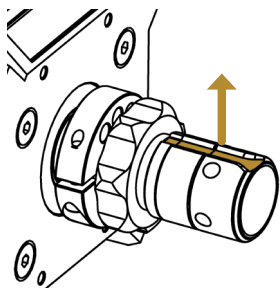

Centre the the Podium Wheel Base DD1 PS4™ Quick Release shaft so that the slot is facing up.

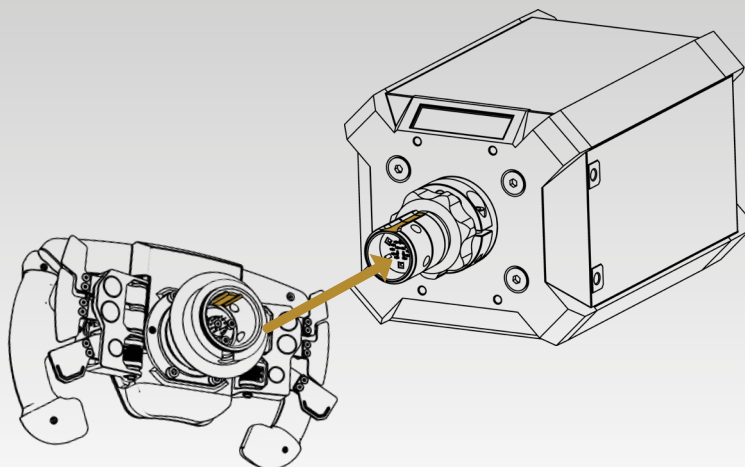

Pull and hold the Quick Release sleeve and carefully push the steering wheel onto the shaft.

When using the Fanatec ClubSport Quick Release on a Podium Series wheel base, no bolt is required.

⚠ IMPORTANT: Take care not to use high forces when attaching the steering wheel. Make sure the locking ring is not tightened when attaching the rim.

Now release the sleeve of the Quick Release mechanism and turn the locking ring by hand in a counter clockwise for a tight fit.

Proceed in reverse order to remove the wheel from the base.

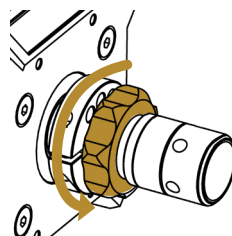

⚠ ATTENTION: Do not over-tighten or use any tools to tighten the locking ring.

6.5 Changing the Quick Release

Make sure your wheel base is off and unplugged.

Position the locking ring until it touches the rubber gasket, but do not tighten. This keeps the rubber gasket in place.

Now loosen the bolts of the black clamp ring at the end of the steering axle.

Turn the locking ring clockwise until it reaches the end of the shaft. Continue to rotate the locking ring clockwise while holding the steering axle in place with your other hand. The locking ring will slowly push the Quick Release out.

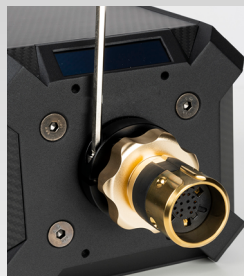

⚠ IMPORTANT: DO NOT pull out the steering axle forcefully by hand other wise it is possible to tear off the cables inside the steering axle.

Once the locking ring begins to push the Quick Release out, it should come out very easily.

Unravel the cables inside the wheel base to give you more space.

Disconnect the two cables by lifting the locking tabs of each connector.

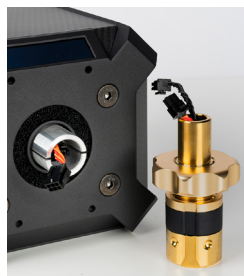

Now connect your new Quick Release system in the same way with the matching cables (the short QR cable connects to the long wheel base cable, and the long QR cable connects to the short wheel base cable).

Twist the cable by turning the Quick Release five times to avoid damaging the cables inside the wheel base.

NOTE: The wheel base shaft has a step where the inner diameter decreases. It's important that the connectors clear this step to avoid damaging the cables during reassembly. If necessary, you can try to push the connectors carefully with a flat tool to pass the step.

Turn the locking ring counter-clockwise until it touches the rubber gasket before you insert the new steering axle.

Push the new steering axle carefully into the wheel base until you feel resistance from the step in the shaft.

Put on the clamp ring and tighten the bolts evenly.

NOTE: When re-attaching the QR clamp to the wheel base shaft, ensure that both gaps are aligned, as marked by the red line in the image below:



NOTE: You will have to re-calibrate the wheel centre after making any adjustments to the Quick Release.

6.6 Connections

To connect additional peripheral devices like shifters, pedals or handbrake to the Podium Wheel Base DD1 PS4™ there is a row of connector sockets at the rear of the wheel base:

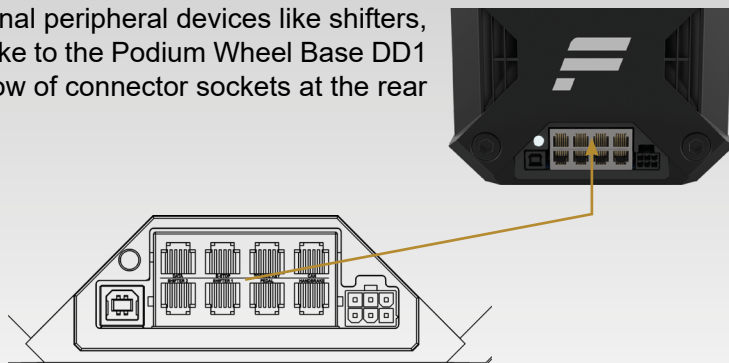

⚠ IMPORTANT: Use only the cables which are included with your wheel base! Peripheral devices are not included and sold separately!

6.6.1 USB

The USB port is used to connect the Podium Racing Wheel F1® to PlayStation®4 or other platforms*.

⚠ IMPORTANT: Use only the included USB cable to avoid damage and/or malfunction!

6.6.2 SHIFTER1

The SHIFTER1 port is used to connect H-pattern shifters to the Podium Racing Wheel F1® (e.g. the ClubSport Shifter or the ClubSport Shifter SQ in H-pattern mode.) Sequential shifters can also be connected to this port. Note: Sequential shifters connected to this port can be mapped identically to the shifter paddles at the ClubSport Steering Wheel F1® PS4™ or any other Fanatec® steering wheels by PC* driver settings (see chapter 'PC* driver' of this user manual).

*PC compatibility not tested nor endorsed by Sony Interactive Entertainment Europe

6.6.3 SHIFTER2

The SHIFTER2 port is used to connect sequential shifters to the Podium Racing Wheel F1® (e.g. the ClubSport Shifter SQ in SQ mode or the ClubSport Static Shifter Paddles.) Note: Sequential shifters connected to this port can be mapped identically to the shifter paddles on the ClubSport Steering Wheel F1® PS4™ or any other Fanatec® steering wheels by PC* driver settings (see chapter 'PC* driver' of this user manual).

Attention: H-pattern shifters will not work on SHIFTER2 port!

6.6.4 PEDAL

The PEDAL port is used to connect pedals to the Podium Racing Wheel F1® (e.g. the ClubSport V3 and Clubsport V3 inverted).

6.6.5 HANDBRAKE

The HANDBRAKE port is used to connect the ClubSport Handbrake V1.5 to the Podium Racing Wheel F1®.

6.6.6 POWER

The POWER connector is used to connect the power supply to the Podium Racing Wheel F1®.

6.6.7 DATA

The DATA port is to be used for future accessories such as LED displays.

6.6.8 E-STOP

The E-STOP port is for use with the optional Podium Kill Switch.

6.6.9 TORQUE KEY

The TORQUE KEY port is for use with the included Torque Key.

6.6.10 CAN

The CAN port is to be used for future CAN bus support.

 **IMPORTANT:** Please use only the power supply and power cord that came with your Podium Racing Wheel F1®. Replacements may only be issued from an authorised repair centre. See 'Electrical Safety' in Chapter 1 'General' for more details!

*PC compatibility not tested nor endorsed by Sony Interactive Entertainment Europe

6.7 Drilling Template

Please download and print the drilling template for hard-mounting the Podium Racing Wheel F1® from the download area of our website www.fanatec.com.

The Podium Racing Wheel F1® supports a variety of different CSL and ClubSport series steering wheels and other peripheral devices like shifters, pedals and handbrakes. You can obtain these add-on products from the Fanatec webshop: www.fanatec.com

Here are some examples:

- ClubSport Steering Wheel Porsche 918 RSR
- ClubSport Steering Wheel Formula Carbon
- ClubSport Steering Wheel F1® Esports
- ClubSport Steering Wheel BMW GT2
- CSL Elite Pedals
- CSL Elite Pedals LC
- ClubSport Pedals V3
- ClubSport Pedals V3 Inverted
- ClubSport Shifter SQ V1.5
- ClubSport Static Shifter Paddles

Note: IF your ClubSport Static Shifter Paddles do not fit over your clamp ring, you will need to briefly remove the clamp. Please see instructions regarding how to remove the clamp. Removing the full QR is NOT necessary.

 **IMPORTANT:** When mounting the clamp again, the gaps from the clamp and the base shaft needs to be equal to secure proper fitment. (See image on page 19.)

For detailed information about the assembly of other peripheral devices please read the corresponding user manual and/or Quick Guide.

7 FUNCTIONS & FEATURES

⚠ IMPORTANT: A Windows PC is mandatory to perform firmware updates!

The Podium Racing Wheel F1® firmware provides the wheel functionality, defines the compatibility and handles the communication between the device to PlayStation®4 or PC* as well as to other peripheral devices like shifters and pedals.

7.1 Firmware and driver update

The firmware and the PC* driver can be updated to newer versions from www.fanatec.com.

The Podium Racing Wheel F1® is fully workable out-of-box and compatible with existing peripheral devices [per May 2019]. Nevertheless we recommend to always use the latest firmware as these updates may include bug fixes or introduction of new features and compatibilities.

You also have to use the latest PC* driver version in order to use the Podium Racing Wheel F1® on a PC*.

Run the downloaded file(s) and follow the instructions shown on the screen. See more detailed description later in this user manual chapter.

7.1.1 PC* driver

The PC* driver is a very helpful tool as it can assist the user in performing functional tests, adjustments, and update procedures on the Podium Racing Wheel F1®.

When you start the driver, this window (right) will appear and show all connected USB devices:

Double-click the FANATEC Podium Wheel Base DD1 to see the complete properties menu.

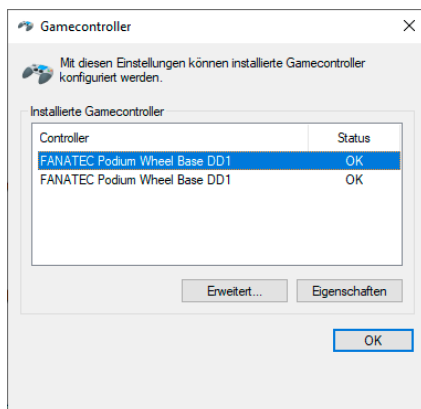

*PC compatibility not tested nor endorsed by Sony Interactive Entertainment Europe

In the Properties menu, 'Function Test' will display the attached Fanatec® Steering Wheel. In this example a ClubSport Steering Wheel F1® PS4™ is shown below:

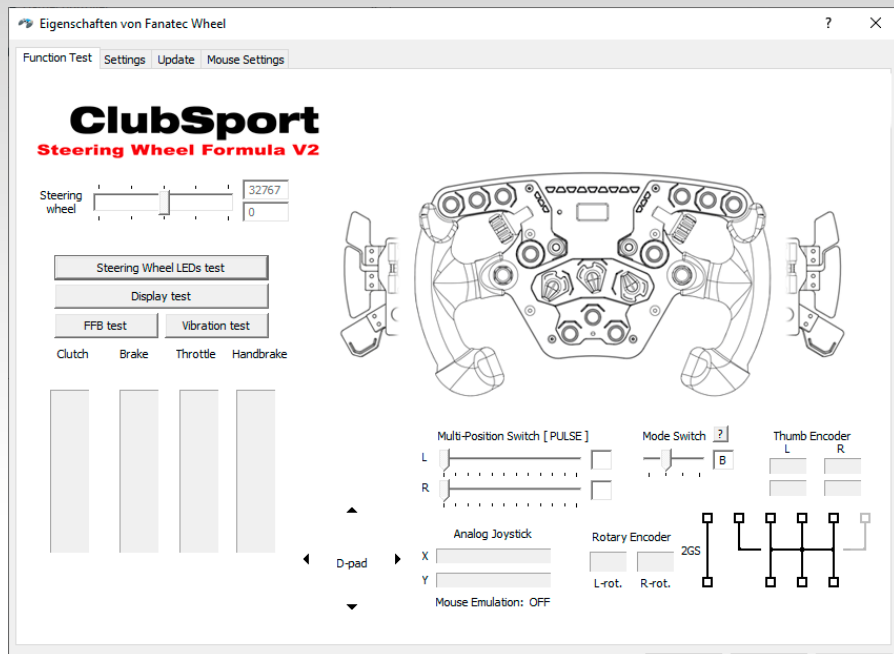

This window provides a lot of diagnostic information and gives the option to test the hardware and peripherals:

Indicator bar shows the current **steering wheel position**, the upper box shows the position in digits, the lower box shows the position as an angle (positive and negative angle related to the calibrated wheel centre position).

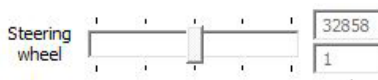

The button **display test** activates a signal flow on the LED display of the attached Fanatec® steering wheel and activates all LED display segments so you can check if all LED display segments work properly.

The button **FFB test** starts a force feedback test and activates the motor of the Podium Racing Wheel F1® to check proper functionality.

The button **Steering Wheel RevLEDs test** starts a signal flow on the LED bar on the steering wheel top side and activates them to test proper functionality of each single LED. This is only available for steering wheels which have Rev-LEDs, refer to the product description of the steering wheel in use.

The button **Vibration Test** starts a vibration signal to activate the vibration motors inside the Fanatec® steering wheels. This is only available for steering wheels which have vibration motors inside, refer to the product description of the steering wheel in use.

The three indicators **Clutch, Brake and Throttle** show the current activation and position of these single pedals by a blue bar moving up and down. Therefore the pedals must be connected to the Podium Racing Wheel F1®.

Note: Every pedal lever must be pressed down completely to auto-calibrate the lever movement distance each time when power resumes.

The **D-pad** arrows (up, down, left, right) change their colour from black to blue when the corresponding direction is pressed on the attached Fanatec® steering wheel.

The **Rotary Encoder** boxes flash blue when turning left or right the FunkySwitch™ (clockwise or counter-clockwise).

The **2GS** indicator shows the activation of the 2GS (two gears shifter, sequential shifter, SQ) by filling the two little squares with blue colour, when activating up shifts or down shifts. This can be for example the ClubSport Static Shifter Paddles or the ClubSport Shifter SQ in sequential mode if these are not mapped to the steering wheel shifter paddles.

The **H-pattern** indicator shows the activation of the 6GS, 7GS or 8GS (six gears shifter, seven gears shifter or eight gears shifter) by filling the little squares with blue colour, depending on activated shifting position. This can be for example the ClubSport Shifter or ClubSport Shifter SQ. Therefore, the H-pattern shifter must be calibrated. See chapter 'Hotkeys' → 'Shifter calibration mode' for more details.

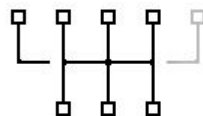
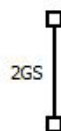
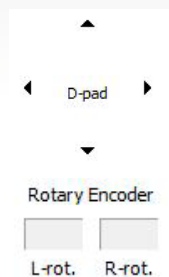
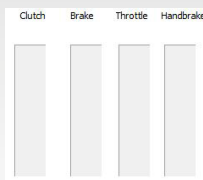

With the **Mode Switch** you can see the selected mode are the analog paddles of the Advanced Paddle Module.

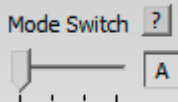

A Clutch bite point** Left & right paddle work in parallel. The paddle that is pressed further is valid.

B Handbrake + Clutch Left: handbrake; right: clutch

C Brake + Throttle Left: brake; right: throttle

D Mappable analog axes paddles can be mapped as two additional axes

Multi-Position Switches: On the ClubSport Steering Wheel F1® PS4™, the two multi-position switches work as two buttons by default. Turning the switch to the left is one button and turning the switch to the right is another button. The bars (right) show the position of the two switches.

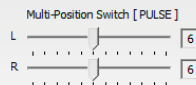

The bars (right) show the position of the two switches.

With the MPS setting, you can select the way the switch behaves.

Pulse: As soon as the position of the switch is changed, a single pulse signal of the new position is sent.

Constant: Each position sends a permanent signal.

Encoder: The switch acts as a rotary encoder.

Automatic: If set to Automatic, the PC Driver or the PS4™ will directly set the value which can be selected by games that support this feature.

Analog Joystick: The analog stick on the left side of the ClubSport Steering Wheel F1® PS4™ has an x-axis and y-axis shown by the two bars (right). The Analog Stick can be used as a mouse on the PC*.

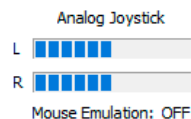

Thumb Encoders: The boxes flash blue when the encoders are rotated upwards or downwards.

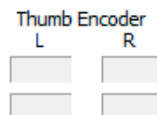

*PC compatibility not tested nor endorsed by Sony Interactive Entertainment Europe

The biggest area in this window is the upper right section of this view. This shows a diagram of the attached Fanatec® steering wheel with all buttons. If you press one of the buttons on the attached steering wheel, the corresponding button will be highlighted with a blue spot as long as the button is physically activated. Please note that this view is dependent on the attached Fanatec® steering wheel. See example picture for the ClubSport Steering Wheel F1® PS4™ (right).



If you go to the PC* driver page 'Settings' you will see this window:

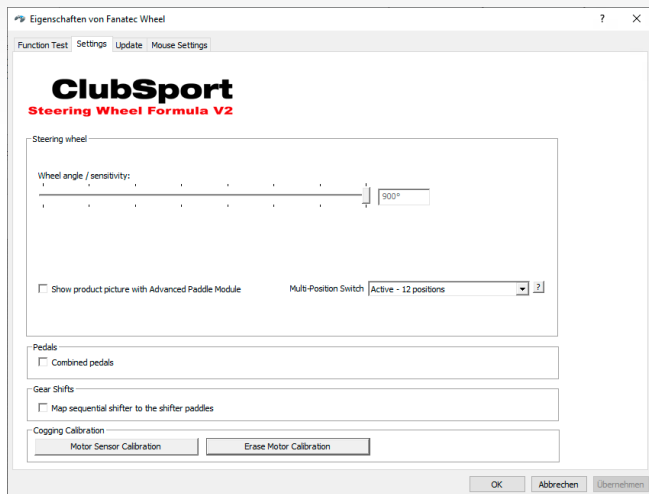

The bar **Wheel angle / sensitivity** can adjust the maximum turning angle of the Podium Racing Wheel F1®, so the functionality is identical with the option 'SEN' in Tuning Menu (see chapter 'Tuning Menu' of this manual for more detailed information). Please note that in Tuning Menu the value for 'SEN' must be set to 'AUTO' to allow the PC* driver to take the control. If in Tuning Menu 'SEN' is set to any other value than 'AUTO' the value set in Tuning Menu is applied and valid and the PC* driver has no influence.

*PC compatibility not tested nor endorsed by Sony Interactive Entertainment Europe

In the **Pedals** section there is only the one checkbox called 'Combined pedals'. Activate this checkbox if the game or software uses only one input (I/O) for brake and throttle pedal signals (negative signal for brake, positive signal for throttle). This might solve problems especially with older games.

In the **Gear shifts** section there is only one checkbox called 'Map sequential shifter to the shifter paddles'. Usually shifters connected to the SHIFTER2 port are mapped to different inputs (I/Os) than the shifter paddles on Fanatec® steering wheels. If you want to change the mapping so that the used inputs for these shifters are identically mapped as for the Fanatec® steering wheel shifter paddles activate this checkbox.

If you go to the PC* driver page 'Update' you will see this window:

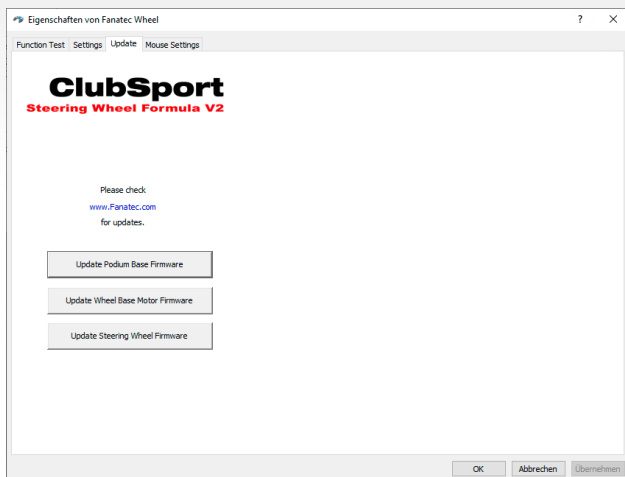

In this window you can see the following information:

- Currently installed and used PC* driver version
- Current Steering Wheel Firmware
- Current Wheel Base Motor Firmware
- Currently installed and used firmware version on the Podium Racing Wheel F1®
- Quick link to the Fanatec® homepage www.fanatec.com

Below the shown information there is the button **Update Podium Base Firmware**. When pressing this button the firmware update process for the Podium Racing Wheel F1® will begin (see more detailed description in chapter 'Firmware update procedure' below in this user manual).

*PC compatibility not tested nor endorsed by Sony Interactive Entertainment Europe

7.1.2 Firmware update procedure

To initiate the firmware update the Podium Racing Wheel F1® first has to be connected to the PC* by USB cable and then it has to be switched to Bootloader mode. You can switch to Bootloader mode in two different ways:

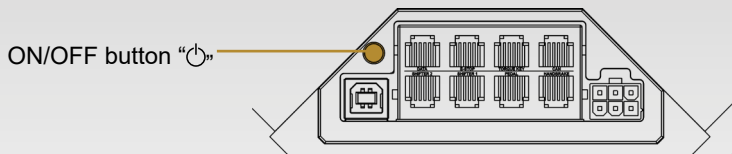

- by PC* driver, on page 'Update' press the button **Update Podium Base Firmware** when the Podium Racing Wheel F1® is switched ON, see previous chapter 'PC* driver'
- by pressing the ON/OFF button "⏻" on the back plate of the Podium Racing Wheel F1® for about 8 seconds when the Podium Racing Wheel F1® is switched OFF.

When the Bootloader mode is active the LED of the ON/OFF button "⏻" will be flashing blue. The cooling fan will also switch off. On the PC* screen this window will appear automatically (shown right).

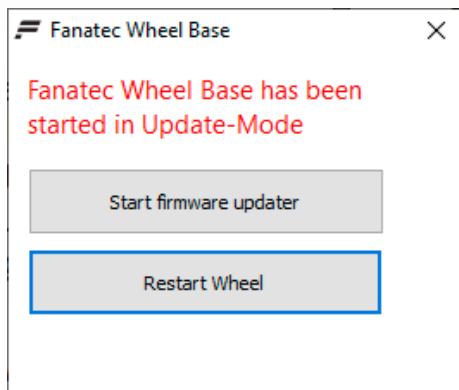

Click on the upper button 'Start firmware updater'.

Then a new window will appear (shown right):

Connect to your Podium Racing Wheel F1® by pressing the button 'Connect'.

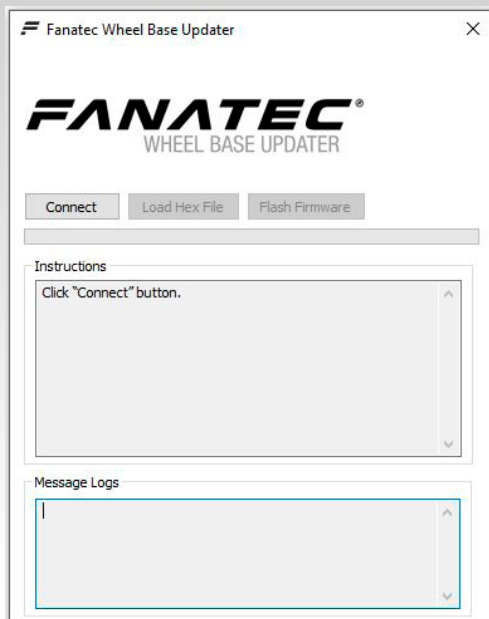

When the Wheel Base Updater is connected to the Podium Racing Wheel F1® the buttons 'Load Hex File' and 'Flash Firmware' are available (shown right).

Use button 'Load Hex File' to browse and select the wanted firmware file (.hex). Usually the latest available firmware found is already pre-selected and this step can be skipped.

When the pre-selected firmware file (.hex) is correct or the wanted firmware file (.hex) is chosen, press button 'Flash Firmware' to execute the firmware update.

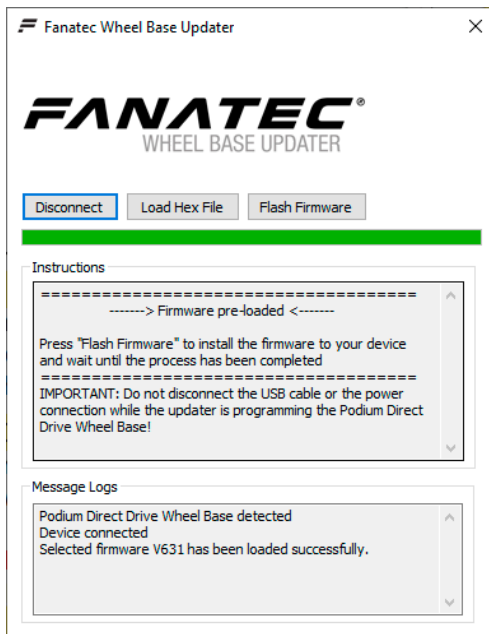

*PC compatibility not tested nor endorsed by Sony Interactive Entertainment Europe

The firmware update is proceeding. You can see the progress bar in green (shown right).

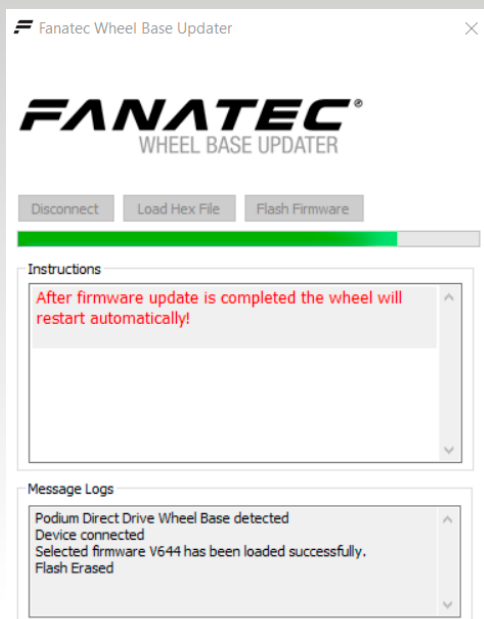

When the update is done the Podium Racing Wheel F1® will restart automatically after firmware update is completely finished (shown right):

The Podium Racing Wheel F1® switches off and automatically on again and then will execute the calibration run.

⚠ IMPORTANT: Do not touch the attached steering wheel while the Podium Racing Wheel F1® restarts and performs the initial calibration run to avoid injuries and/or miscalibration!

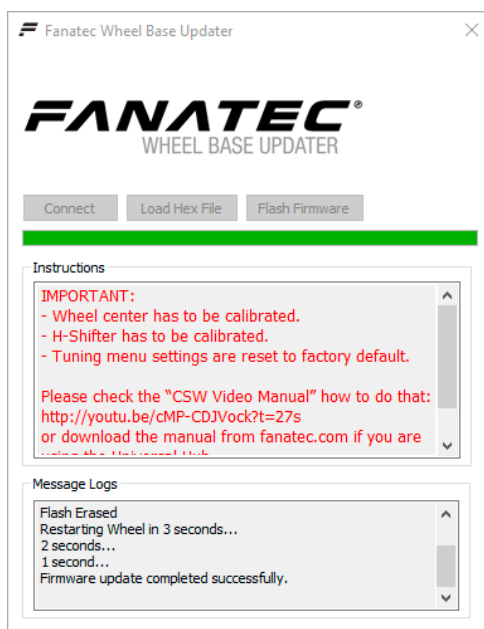



⚠ IMPORTANT: Software measures protect the product from installation of wrong firmwares on the device. Do not try to force install any firmware.

⚠ IMPORTANT: After firmware update the centre position of the Podium Racing Wheel F1® has to be manually calibrated again. This is also indicated by the OLED display of the steering wheel showing 'CAL'. This message will disappear after manual calibration of the wheel centre. See chapter 'Hotkeys'  'Wheel centre calibration' for more details.

⚠ IMPORTANT: After firmware update the H-pattern shifters connected to the Podium Racing Wheel F1® has to be manually calibrated again. See chapter 'Hotkeys'  'Shifter calibration mode' for more details.

7.2 Start-Up procedure

⚠ ATTENTION: When initialisation and auto calibration of the Podium Racing Wheel F1® is in progress never touch the attached steering wheel in order to avoid injuries or incorrect calibration!

- **Step 1:** Press the ON/OFF button  at the back plate of the Podium Racing Wheel F1®, marked in the picture on the right hand side:
- **Step 2:** The fans start working, the LED in the ON/OFF Button  lights up.
- **Step 3:** The Podium Racing Wheel F1® will rotate the rim to a certain position, and then rotate back to centre.
- **Step 4:** The currently installed firmware version is briefly displayed on the



OLED of the Fanatec® steering wheel.

- **Step 5:** If the wheel centre was not yet calibrated 'CAL' will blink on the OLED display of the steering wheel (shown right).
 - Proceed with a manual wheel centre calibration as described in chapter 'Hotkeys' of this manual.
 - The Podium Racing Wheel F1® is ready to use after manual wheel centre calibration.
- **Step 6:** Your Podium Racing Wheel F1® is ready to use. If the wheel centre was previously calibrated, step 5 can be skipped and the Podium Racing Wheel F1® is ready to use immediately. If you use a H-pattern shifter the wheel base firmware will request to calibrate the gears automatically now. Refer to chapter 'Shifter calibration mode' later in this user manual.

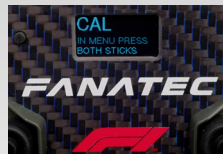

7.3 Tuning Menu

Activate the Tuning Menu by pressing the Tuning Menu button (see the 'Hotkeys' chapter of this user manual). The menu will be shown on the tuning display of the Fanatec® steering wheels. To navigate through the Tuning Menu, use the

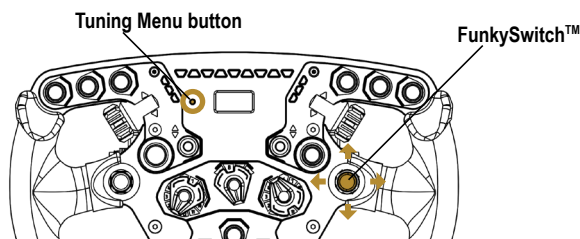

directional stick of the Fanatec® steering wheel.

Note: Tuning functions are subject to change and may be altered in future firmware versions.

7.3.1 S_1 ... S_5 (Setups)

Setups range: S_1 ... S_5

Setups default: S_1

The Podium Racing Wheel F1® provides five different setups to store your adjusted values independently from each other. To change which setup is active, move the directional stick of the Fanatec® steering wheel in the up or down direction.

There is also an 'S_0' setup that is locked to default settings.

7.3.2 SEN (Sensitivity)

SEN range: 90 ... 1080 → AUTO

SEN default: AUTO

The sensitivity defines the steering angle. If SEN is set to 90 the steering wheel can only be turned 90° (45° to left and 45° to right side direction from calibrated centre position). If SEN is set to 1080 the steering wheel can be turned the maximum lock of 1080° (540° to left and 540° to right side direction from calibrated centre position). If SEN is set to AUTO the sensitivity is controlled by the PC* driver (see chapter PC* driver for more details) or games can directly support this feature.

7.3.3 FF (Force Feedback)

FF range: OFF → 001 ... 100

FF default: 35

The Force Feedback defines the maximum strength of the motor when force feedback effects from software / games are sent to the Podium Racing Wheel F1®. If FF is set to OFF, there will be no force feedback effect executed by the Podium Racing Wheel F1® motor. If FF is set to 001, the motor will execute only 1% of the maximum motor power. If FF is set to 100, the motor will execute 100% of the maximum motor power.

7.3.4 SHO (Shock)

SHO range: OFF → 010 ... 100

SHO default: 100

The strength of the shock / vibration motors inside the Fanatec® steering wheel can be adjusted from 100% to 0%. These vibration motors can be used by a game directly (Fanatec® SDK) or by the ABS function.

7.3.5 ABS

ABS range: 000 ... 100 → OFF

ABS default: OFF

This feature gives you a direct feedback based on your brake inputs. If you set the value to 100 the vibration will start as soon as you give 100% brake input to the game. If you set it to 95% the vibration will start if you push the brake to 95% or more. The ABS feature uses the vibration within your wheel rim (can be turned off by setting SHO to "0") AND the vibration motor on a CSP (V2 or V3) pedal set if it is connected directly to the wheel - not individually by USB. ABS can also be simulated dynamically by the game if the developer makes use of

*PC compatibility not tested nor endorsed by Sony Interactive Entertainment Europe

the Fanatec® SDK.

7.3.6 Force Effect, Spring Effect, Damper Effect

FOR range: OFF → 010 ... 120

FOR default: 100 (%)

SPR range: OFF → 010 ... 120

SPR default: 100 (%)

DPR range: OFF → 010 ... 120

DPR default: 100 (%)

These force feedback modifiers give you the ability to change the force feedback signals of a game (only applicable if game uses these effects). In theory there are three types of signals which a game can send: Force (pushes the wheel into a specific direction), spring (pulls the wheel towards the dynamic centre) and damper (creates friction). Not every game uses all types of effects and some games even use only one type to create all different feelings. Using your Tuning Menu in the Podium Racing Wheel F1® you can increase or reduce these different effects individually.

Note: If SPR is set to low values or 'OFF' the Podium Racing Wheel F1® will not be able to move the attached steering wheel to correct centre position after calibration run.

 **IMPORTANT:** Only set these values higher than 100% if the force feedback effects are clearly not strong enough and weaker in comparison to other games. When the game sends full effects and the wheel is set to 100%, the device will work at its power limit. Pushing up one value to a very high number or even raising multiple values will result in higher load on the motor and increased heat development.

For further information check the FAQ section on our website www.fanatec.com/support.

7.3.7 Natural Damper

NAT DMP range: OFF ... 100

NAT DMP default: 050

The natural damper will give you an additional damper which you can adjust from OFF to 100. At 100 you will have the strongest dampening effect which reacts to the acceleration and angle of your steering. If you turn it OFF, your steering will have no additional damping, making it easier to turn the wheel.

The Natural Damper is a useful setting to reduce unwanted wheel oscillation. Oscillation is typically caused by latency in the feedback loop, and is more apparent in racing games that are not optimised for high-torque motors.

The default value of 50 is a good balance between steering responsiveness and oscillation mitigation.

7.3.8 Natural Friction

NFR range: OFF ... 100

NFR default: Off

The natural friction setting is used to simulate the mechanical feel of a vehicle's steering components. The higher the setting, the more resistance you will feel when rotating the wheel. This can enhance the feeling of driving vehicles without power steering, or with very wide tyres. This setting can also help to prevent oscillation.

7.3.9 Force Effect Intensity

FEI range: 0 ... 100

FEI default: 100

This parameter adjusts the overall intensity of force effects and can make effects smoother: OFF is very smooth while 100 is very sharp and direct. Tuning this parameter can help to refine a harsh or spiky force feedback signal in some games.

7.3.10 MPS (Function of Multi Position Switch)

MPS: Auto; Encoder; Constant; Pulse

MPS default: AUTO

In AUTO mode the steering wheel decides which mode is appropriate for the game being played.

In Encoder mode the MPS simulates two buttons, one when you turn the MPS left and one when you turn the MPS right.

In Constant mode, the MPS outputs a constant button signal for each position. In PULSE Mode, the MPS outputs a specific button signal for each position which is only sent as a single pulse when you move the switch.

7.3.11 BRF (brake force)

BRF range: OFF 010 ... 100

BRF default: 050



BRF allows to adjust the brake feeling: Increasing BRF to 100 means the user needs to press the brake with minimum force to achieve 100% brake signal. Reducing BRF to OFF means the user needs to press the brake only with maximum force to achieve 100% brake signal. You can either check the brake signal level on the PC driver or you can see it on the attached steering wheel (depending on steering wheel type).

*PC compatibility not tested nor endorsed by Sony Interactive Entertainment Europe

NOTE: BRF is only available when a supported pedal set is connected to wheel base’s PEDAL port. Please read the description and/or manuals of your pedals to verify if the BRF feature is supported.

7.4 OLED Display

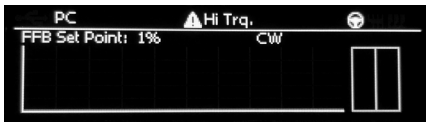
The Podium Racing Wheel F1® features an OLED Display which shows by default the Fanatec logo, detected peripherals, USB connection and operation mode. The display can also show alternative screens with different data, for example installed firmware versions, torque curves or device temperatures. To switch the screens first **PRESS AND HOLD** the Tuning Menu button of the attached steering wheel and then navigate through the screens by FunkySwitch™ directions. Refer to the user manual for more details about the screens and also to the individual quick guides of the steering wheels for the Tuning Menu button and FunkySwitch™.

FUNKYSWITCH™	DISPLAY	MENU TITLE
		Default Screen
↔		Force Feedback Analysis
↔		Motor Data Analysis
↔		Temperature Analysis

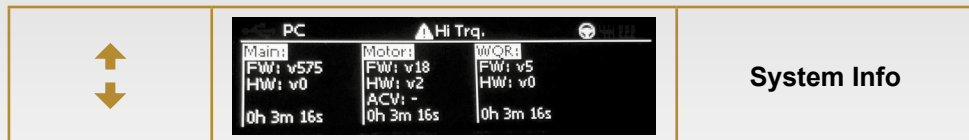
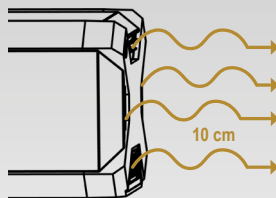
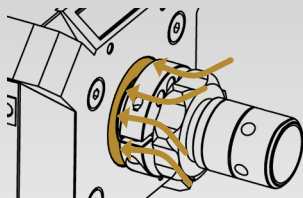

7.5 Cooling system

To avoid damage to the Podium Racing Wheel F1® there is an effective cooling system integrated to the hardware and the firmware.

7.5.1 Hardware measures

The Podium Wheel Base DD1 PS4™ uses an internal fan to expel hot air from the back of the device.

Note: Do not cover the air intake on the front side with accessories, and do not place any items in a 10cm range behind the wheel base to allow proper cooling airflow.

7.5.2 Automatic fan adjustment

The firmware provides different stages of fan control which are clearly defined after intensive lab testing.

When switching ON, the Podium Racing Wheel F1® fan operates at maximum speed until calibration run is completed.

The operation speed of the fan is adjusted according to the currently detected temperature of the motor inside the Podium Racing Wheel F1® and could even stop, depending on your firmware version.

The temperature control and fan behaviour is subject to change by firmware updates.

8 ELECTRICAL OPERATION

8.1 Hotkeys

8.1.1 Tuning Menu

To enter the Tuning Menu, use the Tuning Menu button. The picture shows the Tuning Menu button of the ClubSport Steering Wheel F1® PS4™ as an example:



8.1.2 Restore original Tuning Menu settings

To restore the original Tuning Menu settings, open the Tuning Menu. **SET 1** will be shown on the tuning display. Then press and hold the Tuning Menu button for about five seconds until **RESET - Default Values** is displayed on the ClubSport Steering Wheel F1® PS4™ and the OLED Display of the Podium Racing Wheel F1®.

8.1.3 Wheel centre calibration

If a centre calibration is needed (e.g. after updating the firmware of the Podium Racing Wheel F1®) first you need to enter the Tuning Menu as described above.

When you use the ClubSport Steering Wheel F1® PS4™ you must press both sticks at the same time.



Please see corresponding quick guide of the Fanatec® steering wheel you use with the Podium Racing Wheel F1®.

⚠ ATTENTION: When initialisation and auto calibration of the Podium Racing Wheel F1® is in progress never touch the attached steering wheel in order to avoid injuries or incorrect calibration!

8.1.4 Switching modes

The Podium Racing Wheel F1® will start in “PC” by default. The OLED Display of the wheel base will show in the upper left corner the current operation mode:

To change modes, simultaneously press the two highlighted buttons below.

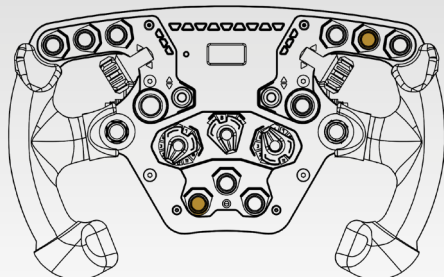

NOTE: USB update rate up to 250Hz for PS5™ in PS® mode.

NOTE: Each steering wheel has a different button press combination in order to change modes. Please see your wheel’s quick guide in order to see which button press combination is required.

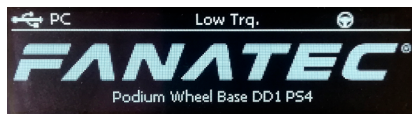
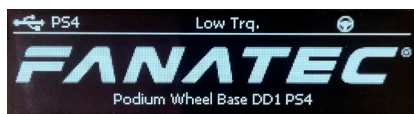

- PS4™: To operate with PlayStation®4 and any Fanatec steering wheel**
- PC*: To operate with Windows PCs* and any Fanatec steering wheel**
- Comp V2.5: To operate with older games on Windows PCs* use this mode to emulate a ClubSport Wheel Base V2.5 with any Fanatec steering wheel**. There is no performance penalty when using this mode.
- Comp PS4™: Some older games on Playstation®4 may require the use of this mode, which emulates a CSL Elite Wheel Base + with any Fanatec steering wheel**

NOTE: Once the mode is changed manually the Podium Racing Wheel F1® will remember the last active mode and will boot in the same mode next time. Exception: After firmware update is done.

*PC compatibility not tested nor endorsed by Sony Interactive Entertainment Europe

** optional and not included in this product package

8.1.5 Shifter calibration mode

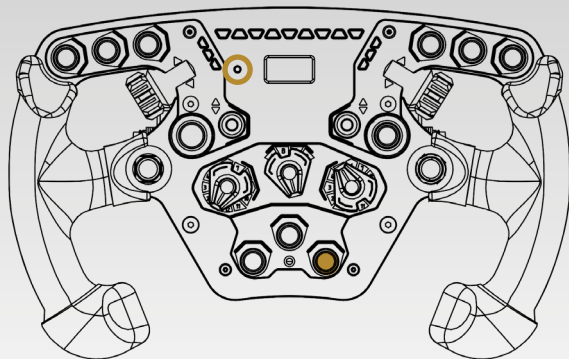

To enter the H-pattern shifter calibration mode press the shown buttons of the ClubSport Steering Wheel F1® PS4™ at the same time while H-pattern shifter is connected, see picture (above).

For other Fanatec® steering wheels please refer to the corresponding quick guide for more detailed information.

⚠ NOTE: After firmware update the Podium Racing Wheel F1® will request the shifter calibration automatically as soon as a non-calibrated H-pattern shifter is connected and detected. The menu will guide you through the calibration steps as described on the next page.

Put the H-pattern shifter's lever into the position shown on the OLED display and acknowledge each single position by pressing the **FunkySwitch™** to get to the next one.

The following pictures show the instructions on the OLED display of the Club-Sport Steering Wheel F1® PS4™ but are similar on the other Fanatec® steering wheels:



If your shifter has no 7th gear just acknowledge it by pressing the **FunkySwitch™** when the shifter lever is physically in position of 6th gear. After all gears are calibrated the OLED display shows SET 1 and the shifter is ready for use.

⚠ NOTE: If you did not intend to enter the shifter calibration mode simply complete the calibration process either without a connected shifter or without moving the shifter lever. You may then leave the shifter calibration mode at the end of the process. This has no impact on the Podium Racing Wheel F1® original calibration itself and you can go ahead without a shifter.

9

CLEANING

Clean only with a dry or slightly damp cloth. Using cleaning solutions may damage your Podium Racing Wheel F1®.

10

TROUBLESHOOTING

The Podium Racing Wheel F1® must not be modified differently than described in this manual. Endor® AG expressly prohibits analysis and utilisation of the electronics, hardware, software and firmware contained in the controller. In case difficulties occur in connection with utilisation of the Podium Racing Wheel F1®, please use the following guide for elimination of errors. On the website www.fanatec.com/support you will find further details and contact data.

If the Podium Racing Wheel F1® is not working properly:

Problem description	Solution
After firmware update of the Podium Racing Wheel F1® the steering wheel is not properly centred.	After applying a firmware update on the Podium Racing Wheel F1® the wheel centre position must be manually calibrated. See chapter 'Electrical Operation' → 'Wheel centre calibration' of this manual for more details.
After firmware update of the Podium Racing Wheel F1® the H-pattern shifter is not working properly.	After applying a firmware update on the Podium Racing Wheel F1® the H-pattern shifter must be manually calibrated. See chapter 'Electrical Operation' → 'Shifter Calibration Mode' of this manual for more details.
The driver window does not show the attached steering wheel.	Make sure that you have updated your Podium Racing Wheel F1® to the latest firmware version which can be downloaded from www.fanatec.com/support .
	Check the pins inside the Quick Release of the steering wheel, these must not be bent or damaged.
	Try to use another steering wheel. If this is also not detected the Podium Racing Wheel F1® might be damaged.

Problem description	Solution
The tuning display does not show anything or is not working properly.	<p>Try to use another steering wheel. If this is also not working properly the Podium Racing Wheel F1® might be damaged.</p> <p>Check the pins inside the Quick Release of the steering wheel, these must not be bent or damaged.</p>
After switching on the Podium Racing Wheel F1® the auto calibration is not working properly.	Make sure that you have updated your Podium Racing Wheel F1® to the latest firmware version which can be downloaded from www.fanatec.com/support .
After playing a while the Podium Racing Wheel F1® seems to become weaker or is fading.	<p>When the motor temperature is close to the upper limit the Tuning Menu values will be overwritten to regular maximum values (not higher than 100 %).</p> <p>Additionally, the motor power level is controlled by firmware so that the FFB strength may fade in this high temperature range but the motor will not be damaged. This allows extending the duration of driving before the motor has to completely stop operating to calm down.</p> <p>Let your Podium Racing Wheel F1® cool down before continuing to use it.</p>
After playing a while the Podium Racing Wheel F1® motor has switched OFF.	<p>When the temperature is exceeding the upper limit the motor will be deactivated for a while until the temperature is low enough (to protect the hardware from damages).</p> <p>Let your Podium Wheel Base DD2 cool down before continuing to use it. Contact our customer support if this happens consecutively.</p>
Fan is always working in full speed even though the Podium Racing Wheel F1® was just powered ON and did not heat up due to driving yet.	In case of malfunctioning temperature sensor the fans will work at maximum speed to protect the hardware from overheating. Please contact our customer support. Note: Operating room temperature: 15°C-35°C.
After calibration run at startup of Podium Racing Wheel F1® the attached steering wheel doesn't go to correct centre position.	Please check your Tuning Menu settings, the value for SPR (spring) must be higher than '000' as this effect is required to make correct centring. Default value is '100'.

11 SERIAL NUMBER

Before contacting the Fanatec® Customer Support please note the serial number of your Podium Racing Wheel F1®:

- Podium Wheel Base DD1 PS4™:
- ClubSport Steering Wheel F1® PS4™:

To find your serial number, you must lift the top housing cover off. It is held on by magnets and can be lifted from the rear side up. and of your ClubSport Steering Wheel F1® PS4™ on sticker on the backside of the lower stroke of the steering wheel.

The serial number of the Podium Wheel Base DD1 PS4™ starts with letters 'MG' and has additional 8 numbers, for example: **MG12704023**.

The serial number of the ClubSport Steering Wheel F1® PS4™ starts with letters 'HZ' and has additional 8 numbers, for example: **HZ10703012**



12 TRADEMARKS

“PlayStation” and the “PS” Family logo are registered trademarks of Sony Interactive Entertainment Inc. All rights reserved.

“Fanatec®” and “Endor®” are registered trademarks of Endor® AG/Germany. All rights reserved.

All other trademarks are the property of their respective owners.

13

END OF LIFE PRODUCT RECYCLING

Please follow your local regulations when disposing of this product as e-waste.

English: The European Union's WEEE directive requires that products sold into EU countries must have the crossed out trash bin label on the product (or the package in some cases). As defined by the WEEE directive, this cross-out trash bin label means that customers and end-users in EU countries should not dispose of electronic and electrical equipment or accessories in household waste. Customers or end-users in EU countries should contact their local equipment supplier representative or service centre for information about the waste collection system in their country.



EU & TR

German: Gemäß der WEEE-Richtlinie der Europäischen Union müssen Produkte, die in EU-Länder verkauft werden, auf dem Produkt (oder in manchen Fällen auf der Verpackung) ein durchgestrichenes Mülleimer-Etikett enthalten. Im Sinne der WEEE-Richtlinie bedeutet diese durchgestrichene Mülltonne, dass Kunden und Endbenutzer in EU-Ländern elektronische und elektrische Geräte oder Zubehör nicht mit dem Hausmüll entsorgen dürfen. Kunden oder Endbenutzer in EU-Ländern sollten sich an ihren örtlichen Lieferanten oder Servicecentre wenden, um Informationen über das Abfallsammelsystem in ihrem Land zu erhalten.

Dutch: De Europese Unie WEEE-richtlijn vereist dat producten die worden verkocht in EU-landen, dat het doorgekruiste prullenbak-etiket op het product (of het pakket in sommige gevallen) moeten hebben. Zoals gedefinieerd door de WEEE-richtlijn, betekent dit doorgekruiste prullenbak-etiket dat klanten en eindgebruikers in EU-landen geen elektrische en elektronische apparatuur of accessoires mogen weggooien bij huishoudelijk afval. Klanten of eindgebruikers in EU-landen moeten contact opnemen met de vertegenwoordiger van hun lokale leverancier of het servicecentrum voor informatie over het afval verzamelsysteem in hun land.

French: La directive de l'Union européenne sur les DEEE exige que les produits vendus dans les pays de l'UE portent une étiquette de poubelle barrée sur le produit (ou l'emballage dans certains cas). Tel que défini par la directive WEEE, cette étiquette rayée de poubelle signifie que les clients et les utilisateurs finaux des pays de l'UE ne doivent pas éliminer leurs équipements et accessoires électroniques et électriques avec leurs ordures ménagères. Les clients ou les utilisateurs finaux dans les pays de l'UE doivent contacter leur représentant du fournisseur d'équipement ou leur centre de service local pour obtenir des informations sur le système de collecte des déchets de leur pays.

Italian: La direttiva WEEE dei sindacati europei richiede che i prodotti venduti nei paesi dell'EU debbano avere l'etichetta del bidone dei rifiuti barrata (o del cestino in alcuni casi). Come definita dalla direttiva WEEE, questa etichetta del bidone dei rifiuti barrata significa che i clienti e gli utenti finali nei paesi dell'EU non devono smaltire apparecchiature elettriche ed elettroniche o accessori, nei rifiuti domestici. I clienti o gli utenti finali nei paesi dell'EU devono contattare il proprio rappresentante del fornitore di apparecchiature locali o il centro di assistenza per informazioni sul sistema di raccolta dei rifiuti nel loro paese.

Spanish: La directiva WEEE de la Unión Europea requiere que los productos vendidos en países de la UE tengan la etiqueta de un contenedor de basura tachado en el producto (o el paquete en algunos casos). Según lo define la directiva WEEE, esta etiqueta de contenedor de basura tachado significa que los clientes y usuarios finales en los países de la UE no deben desechar equipos electrónicos y eléctricos o sus accesorios en la basura doméstica. Los clientes o usuarios finales en los países de la UE deben consultar con el representante de su proveedor de equipos local o centro de servicio para obtener información sobre el sistema de recolección de residuos en su país.

Portuguese: A diretiva WEEE da União Europeia exige que os produtos vendidos nos países da UE tenham o rótulo de lixeira riscada no produto (ou o pacote em alguns casos). Conforme definido pela diretiva WEEE, esse rótulo de lixeira de vedação significa que os clientes e usuários finais nos países da UE não devem descartar equipamentos eletrônicos ou elétricos ou acessórios em lixo doméstico. Os clientes ou usuários finais dos países da UE devem entrar em contato com o representante local de fornecedores de equipamentos ou o centro de serviços para obter informações sobre o sistema de coleta de lixo em seu país.

Swedish: EU: s WEEE-direktiv kräver att produkter som säljs till EU-länder måste ha etiketten över korsfacket på produkten (eller i vissa fall paketet). I enlighet med WEEE-direktivet innebär detta märkningssmärke för kryssrutor att kunder och slutanvändare i EU-länder inte ska använda elektronisk och elektrisk utrustning eller tillbehör i hushållsavfall. Kunder eller slutanvändare i EU-länderna bör kontakta sin lokala leverantörsleverantör eller servicecentre för information om avfallssamlingssystemet i sitt land.

Danish: EU's WEEE-direktiv kræver, at produkter, der sælges i EU-lande, skal have den krydsede affaldsseddel på produktet (eller pakken i nogle tilfælde). Som defineret i WEEE-direktivet betyder denne kryds-etiket for krydsning af affald, at kunder og slutbrugere i EU-lande ikke må bortskaffe elektronisk og elektrisk udstyr eller tilbehør i husholdningsaffald. Kunder eller slutbrugere i EU-lande skal kontakte deres lokale udstyrsleverandør eller servicecentre for oplysninger om affaldsindsamlingsystemet i deres land.

Finnish: Euroopan unionin sähkö- ja elektroniikkalaiteromua koskevassa direktiivissä edellytetään, että EU-maihin myydyissä tuotteissa on oltava tuotteen (tai joissakin tapauksissa pakkauksen) roskakorin etiketti. Kuten sähkö- ja elektroniikkalaiteromua koskevassa direktiivissä määritellään, tämä roskakorin merkintä tarkoittaa, että EU-maiden asiakkaat ja loppukäyttäjät eivät saa hävittää elektronia ja sähköisiä laitteita tai asusteita kotitalousjätteeseen. EU-maiden asiakkaiden tai loppukäyttäjien tulee ottaa yhteyttä paikalliseen laitetoimittajan edustajaan tai huoltokeskukseen saadakseen tietoa maansa jätehuoltojärjestelmästä.

Irish: Éilíonn Treoir WEEE na gCeardchumainn Eorpacha go gcaithfidh lipéad bruscair bruscair a thrasnú amach ar an táirge (nó an pacáiste i gcásanna áirithe) go dtiocfaidh táirgí a dhíoltar i dtíortha an AE. Mar atá sainmhíneithe ag an treoir WEEE, ciallaíonn an lipéad bruscair bruscair seo trasna nár cheart do chustaiméirí agus d'úsáideoirí deiridh i dtíortha an AE trealamh leictreonach agus leictreachais nó gabhálaís leictreacha a dhiúscairt i ndramháil tí. Ba cheart do chustaiméirí nó d'úsáideoirí deiridh i dtíortha an AE dul i dteagmháil lena n-ionadaí nó a n-ionad seirbhísí soláthraithe trealaimh áitiúil le haghaidh faisnéise faoin gcóras bailithe dramháil ina dtír féin.

Greek: Η οδηγία για τα ΑΗΗΕ της Ευρωπαϊκής Ένωσης απαιτεί τα προϊόντα που πωλούνται σε χώρες της ΕΕ να φέρουν στο προϊόν (ή σε ορισμένες περιπτώσεις) τη διαγραμμένη ετικέτα απορριμμάτων. Όπως ορίζεται στην οδηγία για τα ΑΗΗΕ, αυτή η ετικέτα διαχωριστικών απορριμμάτων απορριμμάτων σημαίνει ότι οι πελάτες και οι τελικοί χρήστες στις χώρες της ΕΕ δεν πρέπει να διαθέτουν ηλεκτρονικό και

ηλεκτρικό εξοπλισμό ή εξαρτήματα στα οικιακά απορρίμματα. Οι πελάτες ή οι τελικοί χρήστες στις χώρες της ΕΕ πρέπει να επικοινωνήσουν με τον τοπικό αντιπρόσωπο προμηθευτών εξοπλισμού ή το κέντρο εξυπηρέτησης πελατών για πληροφορίες σχετικά με το σύστημα συλλογής αποβλήτων στη χώρα τους.

Maltese: Id-direttiva tal-WEEE tal-Unjoni Ewropea tirrikjedi li l-prodotti mibjugħa fil-pajjiżi tal-UE jrid ikollhom it-tikketta tal-kontenitur tal-iskart maqsuma fuq il-prodott (jew il-pakkett f'xi każijiet). Kif iddefinit mid-direttiva WEEE, din it-tikketta tal-kontenitur tal-iskart tfisser li l-konsumaturi u l-utenti finali fil-pajjiżi tal-UE m'għandhomx jiddisponu minn tagħmir jew aċċessorji elettronici u elettrici fi skart domestiku. Klijenti jew utenti finali fil-pajjiżi tal-UE għandhom jikkuntattjaw ir-rappreżentant tal-fornitur tat-tagħmir lokali tagħhom jew iċ-ċentru tas-servizz għal informazzjoni dwar is-sistema tal-gbir tal-iskart f'pajjiżhom.

Bulgarian: Директивата на ЕС относно ОЕЕО изисква продуктите, продавани в страните от ЕС да имат символа със зачертания контейнер за отпадъци върху тях (или в определени случаи върху опаковката). Както е отредено от директивата относно ОЕЕО, символът със зачертания контейнер означава, че клиентите и крайните потребители в страните от ЕС не трябва да изхвърлят електронно и електрическо оборудване или електронни принадлежности в битовите отпадъци. Клиентите или крайните потребители в страните от ЕС трябва да се свържат с представителя на местния доставчик на оборудване или с центъра за информация относно системата за събиране на отпадъци в съответната страна.

Polish: Dyrektywa WEEE (ang. Waste of Electrical and Electronic Equipment / pol. zużyty sprzęt elektryczny i elektroniczny – utylizacja odpadów elektrycznych i elektronicznych) dotycząca Unii Europejskiej wymaga, aby produkty sprzedawane do krajów UE musiały mieć na każdym opakowaniu symbol przekreślonego kosza na śmieci, który oznacza selektywną zbiórkę urządzeń elektrycznych i elektronicznych. Informuje ona o tym, że dany sprzęt nie może zostać wyrzucony do zwykłego pojemnika na odpady. Elektroodpady należy pozostawiać wyłącznie w miejscach do tego przeznaczonych. W razie pytań klienci w krajach UE powinni skontaktować się z lokalnym przedstawicielem dostawcy sprzętu lub centrum serwisowym, aby uzyskać informacje na temat systemu zbiórki odpadów w ich kraju.

Czech: Směrnice WEEE Evropských unií vyžaduje, aby výrobky prodávané v zemích EU obsahovaly štítek s přeškrtnutým odpadním košem na výrobku (nebo v některých případech balení). Jak je definováno směrnici o OEEZ, tento štítek odpadkového koše znamená, že zákazníci a koncoví uživatelé v zemích EU by neměli likvidovat elektronická a elektrická zařízení nebo příslušenství domácího odpadu. Zákazníci nebo koncoví uživatelé v zemích EU by měli kontaktovat svého zástupce místního dodavatele zařízení nebo servisního střediska o informacích o systému sběru odpadu ve své zemi.

Slovak: Smernica o odpade z elektrických a elektronických zariadení v Európskej únii vyžaduje, aby výrobky predávané v krajinách EÚ obsahovali na výrobku (alebo v niektorých prípadoch) označenie přeškrtnutého odpadkového koša. Ako je definované v smernici o OEEZ, tento štítok s priečnym odpadom znamená, že zákazníci a koncoví užívatelia v krajinách EÚ by nemali likvidovať elektronické a elektrické zariadenia alebo príslušenstvo v domácom odpade. Zákazníci alebo koncoví užívatelia v krajinách EÚ by mali kontaktovať svojho zástupcu dodávateľa zariadenia alebo servisného strediska ohľadom informácií o systéme zberu odpadu vo svojej krajine.

Slovenian: Direktiva WEEE o evropskih unijah zahteva, da morajo imeti izdelki, prodani v državi EU, na izdelku označeno prečrtano oznako za smeti (ali pakiranje v nekaterih primerih). Kot določa direktiva WEEE, ta oznaka za smeti za smeti pomeni, da kupci in končni uporabniki v državah EU ne bi smeli odlagati elektronske in električne opreme ali dodatkov v gospodinjske odpadke. Stranke ali končni uporabniki

v državah EU se morajo za informacije o sistemu zbiranja odpadkov v svoji državi obrniti na predstavnike lokalnih dobaviteljev opreme ali na servisne centre.

Hungarian: Az Európai Unió WEEE-irányelv előírja, hogy az EU-ba értékesített termékeknek a terméken (vagy bizonyos esetekben a csomagoláson) meg kell jelölniük az áthúzott szemetet. Az elektromos és elektronikus berendezések hulladékaíróról szóló irányelvben meghatározottak szerint ez az áthúzódo sze-métyűjű címké azt jelenti, hogy az EU-országokban az ügyfelek és a végfelhasználók nem dobhatják el a háztartási hulladék elektronikus és elektromos berendezéseit vagy tartozékait. Az EU-országokban az ügyfelek vagy a végfelhasználók kapcsolatba kell lépniük a helyi berendezések beszállító képviselőjével vagy szervizközpontjával, hogy tájékozódjanak az országuk hulladékgyűjtő rendszeréről.

Romanian: Directiva Uniunii WEEE privind DEEE impune ca produsele vândute în țările UE să aibă eticheta trasată a coşului de gunoi pe produs (sau ambalajul în unele cazuri). Aşa cum este definită de directiva WEEE, această etichetă de coş de gunoi înseamnă că clienții și utilizatorii finali din țările UE nu ar trebui să dispună de echipamente și accesorii electronice și electrice în deşeurile menajere. Clienții sau utilizatorii finali din țările UE ar trebui să contacteze reprezentantul local al furnizorului de echipamente sau centrul de service pentru informații despre sistemul de colectare a deşeurilor din țara lor.

Estonian: Euroopa Liidu WEEE direktiiviga nõutakse, et ELi riikidesse müüdatavatel toodetel peab olema toote (või mõnel juhul pakendi) läbimõeldud prügikasti märgis. Vastavalt elektri- ja elektroonikaseadmete jäätmete direktiivis määratletule tähendab see, et see prügikasti märgis tähendab, et ELi liikmesriikide kliendid ja lõppkasutajad ei tohi elektroonikaseadmeid ega elektriseadmeid ega majapidamisjäätmete tarvikuid kõrvaldada. ELi riikide kliendid või lõppkasutajad peaksid võtma ühendust oma kohaliku varustuse esindaja või teeninduskeskusega, et saada teavet oma riigi jäätmekogumissüsteemi kohta.

Lithuanian: Europos Sąjungos WEEE direktyvoje reikalaujama, kad į ES šalis parduodami produktai turėtų būti paženklinėti šiukšliadėžės etiketė ant gaminių (arba kai kuriais atvejais pakuotės). Kaip apibrėžta EEĮ atliekų direktyvoje, ši kryžminė šiukšlių dėžės etiketė reiškia, kad klientai ir galutiniai vartotojai ES šalyse neturėtų šalinti buitinių atliekų elektronikos ir elektros įrangos ar priedų. Klientai ar galutiniai vartotojai ES šalyse turėtų kreiptis į savo vietinį įrangos tiekėją arba paslaugų centrą, kad gautų informacijos apie atliekų surinkimo sistemą savo šalyje.

Latvian: Eiropas Savienības WEEE direktīvā ir noteikts, ka ES valstīs pārdotajiem izstrādājumiem (vai dažos gadījumos iepakojumam) jābūt marķējumam, kas ir šķērsojis atkritumu tvertni. Kā noteikts EEI A direktīvā, šis šķērsošanas atkritumu tvertnes marķējums nozīmē, ka klienti un galalietotāji ES valstīs nedrīkst atbrīvoties no elektroniskajām un elektriskajām iekārtām vai piederumiem sadzīves atkritumos. Klientiem vai galalietotājiem ES valstīs jāsazinās ar vietējo iekārtu piegādātāju pārstāvi vai pakalpojumu centru, lai iegūtu informāciju par atkritumu savākšanas sistēmu savā valstī.

Turkish: Avrupa Birliği Sendikaları WEEE yönergesi, AB ülkelerine satılan ürünlerin, ürün üzerinde (veya bazı durumlarda paketin üzerinde çarpı işareti bulunan çöp kutusu etiketi) bulunmasını gerektirir. WEEE yönergesinde tanımlandığı gibi, bu çarpı işaretli çöp kutusu etiketi, AB ülkelerindeki müşterilerin ve son kullanıcıların elektronik ve elektrikli ekipmanı veya aksesuarları evsel atıklarla birlikte atmaması gerektiği anlamına gelir. AB ülkelerindeki müşteriler veya son kullanıcılar, ülkelerindeki atık toplama sistemi hakkında bilgi için yerel ekipman tedarikçisi temsilcisine veya servis merkezine başvurmalıdır.

14

FCC COMPLIANCE

This device complies with part 15 of the FCC rules. The operation of this device is subject to the following two conditions:



- This device may not cause harmful interference, and must accept any interference received, including interference that may cause undesired operation.
- This device was not modified different than described explicitly in this user manual.

Note: This device was tested and approved to the limitations for class B of digital devices according to part 15 of the FCC rules. This limitations should ensure an adequate protection against harming interferences in residential areas. However, a warranty for not-occurring of interferences is not assumed.

Do not modify the device different than described explicitly in this user manual. Nevertheless, if you do modifications different from the described in this manual you can be determined to stop the operation of the device.

Imported and distributed by Endor America LLC
8200 Wilshire Blvd. Suite 200 - Beverly Hills CA 90211 - USA
US/CAN: +1 321-655-3524
Email: info.webshop@fanatec.com
Website: www.fanatec.com - www.endor.ag

15

WARRANTY

Endor® AG (“Endor”) or local subsidiaries warrants to the original purchaser that the Fanatec® product, which includes components contained in the retail box with this product will be free from material defects in material and workmanship for a period of one year from the original date of purchase (the “Warranty Period”). This warranty is valid in the country where the product was purchased. **If this product is determined to be materially defective during the warranty period, your sole remedy and Endor’s sole and exclusive liability is limited to the repair or replacement of this product with a factory-recertified product, at Endor’s option.** For purposes of this Limited Hardware Warranty and Liability, “factory recertified” means a product that has been returned to its original specifications.

This warranty does not apply if this product

- a) is used with products that are not expressly declared in the product descriptions as compatible with this product;**
- b) is used with peripherals Endor does not license, expressly approve or sell. This includes non-licensed hardware enhancement devices, controllers, adapters, and power supply devices (“non-licensed/non-approved peripherals”);**
- c) is used for any commercial purpose, including rental or arcade purposes;**
- d) is modified or tampered with contrary to the operating and maintenance instructions;**
- e) is damaged by the acts of God (natural disasters), negligence, accidents, wear and tear, unreasonable use, or by causes unrelated to defective materials or workmanship;**
- f) has the serial number altered, defaced or removed (where applicable);**
- g) has the warranty seal altered, defaced or removed (where applicable).**

This warranty does not cover consumables (such as batteries) or products sold and clearly marked „AS IS“ or with faults. Endor may void this warranty if

- 1) Endor reasonably believes that the product has been used in a manner that violates the terms of a separate end user agreement for firmware,**

- system software or game software;
- 2) the product is used with non-licensed/non-approved peripherals. Consumer assume all risks and liabilities associated with use of third-party products.

This warranty is provided to you in lieu of all other express or implied warranties. This includes warranties of merchantability and fitness for a particular purpose for this product, which Endor disclaims under these terms. However, if applicable law requires any of these warranties, then they are limited in duration to the warranty period.

Except as expressly stated above, Endor excludes all liability for loss of data, loss of profit, or any loss or damage suffered by you or any third party, whether those damages are direct, indirect, consequential, special, or incidental and however arising under any theory of law, as a result of using this product. Some states or provinces do not allow limitations on how long an implied warranty lasts and some states do not allow the exclusion or limitations of consequential or incidental damages, so these limitations or exclusions may not apply to you. This warranty gives you specific legal rights. You may also have other rights which vary from state to state or province to province. The warranty offered by Endor on this product is the same whether or not you register your product.

This warranty does not apply to any system software / firmware that is pre-installed in the purchased product, or is subsequently provided via update or upgrade releases. In case of issues apparently related to system software / firmware as well as any other product related issues, Endor recommends checking the FAQ database at www.fanatec.com/support to see if your problem can be solved there.

English	The F1 logo, FORMULA 1, F1, GRAND PRIX and related marks are trademarks of Formula One Licensing BV, a Formula 1 company. All rights reserved.
Spanish	El logo F1, FORMULA 1, F1, GRAND PRIX y las marcas relacionadas son marcas comerciales de Formula One Licensing BV, una empresa de Formula 1. Todos los derechos reservados.
French	Le logo F1, FORMULA 1, F1, GRAND PRIX et les marques associées, sont des marques déposées de Formula One Licensing BV, une société de Formula 1. Tous droits réservés.
Dutch	Het F1-logo, F1, FORMULA 1, F1, GRAND PRIX en gerelateerde merken zijn handelsmerken van Formula One Licensing BV, een Formula 1-bedrijf. Alle rechten voorbehouden.
German	Das F1-Logo, FORMULA 1, F1, GRAND PRIX, und damit verbundene Marken sind Handelsmarken der Formula One Licensing BV, ein Unternehmen der Formula 1. Alle Rechte vorbehalten.
Hungarian	Az F1 embléma, a FORMULA 1, az F1, a GRAND PRIX és a kapcsolódó jelzések a Formula One Licensing BV védjegyei, mely a Formula 1 csoport egyik vállalata. Minden jog fenntartva.
Italian	Il logo F1, FORMULA 1, F1, GRAND PRIX e relativi marchi sono marchi commerciali di Formula One Licensing BV, una società di Formula 1. Tutti i diritti riservati.
Portuguese	O logótipo F1, FORMULA 1, F1, GRAND PRIX e marcas relacionadas são marcas registadas da Formula One Licensing BV, uma empresa Formula 1. Todos os direitos reservados.
Bulgarian	Логото F1, FORMULA 1, F1, GRAND PRIX и свързаните с тях марки са търговски марки на Formula One Licensing BV, компания на Formula 1. Всички права запазени.
Finnish	F1-logo, FORMULA 1, F1, GRAND PRIX ja vastaavat merkit ovat Formula One Licensing BV:n, Formula 1 -yhtiön tavaramerkkejä. Kaikki oikeudet pidätetään.
Romanian	Siglele F1, FORMULA 1, F1, GRAND PRIX precum și alte mărci asociate, sunt mărci comerciale ce aparțin Formula One Licensing BV, o companie Formula 1. Toate drepturile rezervate.



Manufactured by

ENDOR[®]

Fanatec[®] is a registered trademark of Endor AG
 Designed and developed by Endor AG in Germany
 E.ON-Allee 3 - 84036 Landshut - Germany
 Telephone: +49 (871) 9221-122 Fax: +49 (871) 9221-221
 Email: info.webshop@fanatec.com
 Website: www.fanatec.com - www.endor.ag

Licensed for sale in Europe and Australia and for use exclusively with PlayStation®4.

The F1 FORMULA 1 logo, F1 logo, F1, FORMULA 1, FIA FORMULA ONE WORLD CHAMPIONSHIP, GRAND PRIX and related marks are trade marks of Formula One Licensing BV, a Formula 1 company. All rights reserved.



EU & TR



Contact | 联系方式:
 Endor AG
 E.ON-Allee 3 - 84036 Landshut - Germany
 Telephone | Телефон: +49 (871) 9221-122
 Email | Электронна пошта: info.webshop@fanatec.com
 Цей продукт відповідає вимогам RoHS
 (Директива ЄС 2011/65 / ЄС).

Designed in Germany
 Made in China

Rev. 10